



KEENSERTS® Threaded inserts

Certainly the perfect fit for heavy duty applications

The center of excellence for high-performance fastening technology

KVT-Fastening is an expert for high-quality fastening applications and offers engineering solutions based on the wide product portfolio of the leading manufacturers in the market.



Mechanical engineering | Automotive | Electrical engineering | Energy | Precision engineering | Fluid power | Transportation | Off-shore and Marine | Medical equipment
Aviation and aerospace | Construction industry | Watch manufacturing industry

www.kvt-fastening.com



High-performance solutions from KVT-Fastening are found wherever absolutely safe and secure connections are essential. These small but extremely resilient components play key roles where it matters most – whether in the electronics and energy sector, the automotive and transportation industries, aviation and aerospace, engineering and construction, precision engineering, or medical equipment.

KVT-Fastening does not just supply standard products and individual components, but also provides close and active customer support in the search for ideal solutions, particularly when specific requirements must be fulfilled. This portfolio is complemented by a range of innovative tools and

machines as well as, if needed, the integration into automated serial production workflows.

Ever since 1927, KVT-Fastening has stood for experience, solution-driven know-how, unique expertise in development and consultancy as well as the ultimate in reliability. Since December 2012, KVT-Fastening is a member of the Bossard Group. Bossard is a leading provider of intelligent solutions for industrial fastening technology. The range includes global sales, technical consulting (engineering) and logistics of fastening technology components and bolts. Customers benefit from the extension of competencies in industrial fastening technology and from an optimally enhanced product or service portfolio.



KEENSERTS® threaded inserts – guaranteed reliable fastening solution

KEENSERTS® threaded inserts are the perfect solution to prevent threads from becoming stripped in fields like mechanical or precision engineering, aviation and aerospace. KEENSERTS® are made of stainless steel 1.4305 / AISI 303. They are extremely durable and withstand numerous loosening and tightening cycles without thread stripping. They can be readily used in light metal, steel or cast iron application. They can also be used as an easy and efficient replacement for damaged threads in expensive components.

KEENSERTS® threaded inserts are preassembled with special keys that lock the KEENSERTS® into place to absolutely eliminate rotation and vibration even in heavy-duty applications. Depending on the thread size, KEENSERTS® are available with two or four key locks, both either with normal or self-locking thread.

Benefits

- Easy installation
- Highly durable
- Repair of damaged threads
- Pre-assembled key locks



Contents

Threaded inserts with 2 key locks	6
Threaded inserts with 2 key locks, self-locking	7
Threaded inserts with 4 key locks	8
Threaded inserts with 4 key locks, self-locking	9
Tool, installation	10

All dimensions are specified in mm.

Threaded inserts

2 key locks



Types KNCM, KNM, KNHM

Material

Stainless steel 1.4305 / AISI 303

Extraction force [N]

Shear engagement „A [mm²]“ x ultimate shear strength of parent material „R_m [N/mm²]“

KEENSERTS® with UNC or UNF threads, MS and NAS specification are available upon request.

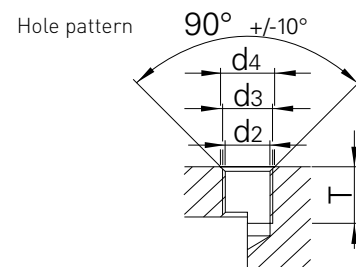
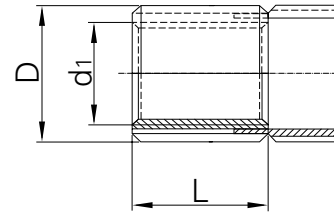

Type KNCM, small series

Thread size d ₁ 5H	Thread size D 4h	Order reference	L ± 0,25	d ₂	d ₃ 6H	d ₄	T min.	A [mm ²]
M3	M5x0,80	KNCM 3x0,5	4,25	4,4	M5x0,80	5,1	6,0	33,1
M4	M6x0,75	KNCM 4x0,7	5,25	5,5	M6x0,75	6,1	7,5	58,4

Type KNM, standard series

Thread size d ₁ 5H	Thread size D 4h	Order reference	L ± 0,3	d ₂	d ₃ 6H	d ₄	T min.	A [mm ²]
M5	M8x1,25	KNM 5x0,8	8,0	6,9	M8x1,25	8,25	10,5	104,9
M6	M10x1,25	KNM 6x1	10,0	8,8	M10x1,25	10,25	13,0	177,7

Type KNHM, heavy-duty series

Thread size d ₁ 5H	Thread size D 4h	Order reference	L ± 0,3	d ₂	d ₃ 6H	d ₄	T min.	A [mm ²]
M5	M10x1,25	KNHM 5x0,8	10,0	8,8	M10x1,25	10,25	13,0	177,7
M6	M12x1,25	KNHM 6x1	12,0	10,8	M12x1,25	12,25	15,5	266,7

Threaded inserts

2 key locks, self-locking



Types KNML, KNHML

The self-locking feature is designed similarly to MIL-N-25027 and supplied with MIL-L8937 lubrication.

Material

Stainless steel 1.4305 / AISI 303 with Molykote® surface treatment

Extraction force [N]

Shear engagement „A [mm²]“ x ultimate shear strength of parent material „R_m [N/mm²]“

KEENSERTS® with UNC or UNF threads, MS and NAS specification are available upon request.

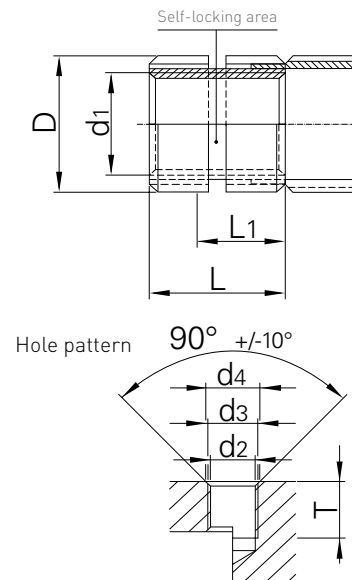

Type KNML, standard series

Thread size d ₁ 5H	Thread size D 4h	Order reference	L ± 0,3	L ₁ * L ₁	d ₂ 	d ₃ 6H	d ₄	T min.	A [mm ²]
M5	M8 x1,25	KNML 5x0,8	8,0	7,6	6,9	M8x1,25	8,25	10,5	83,1
M6	M10x1,25	KNML 6x1	10,0	8,2	8,8	M10x1,25	10,25	13,0	152,7

Type KNHML, heavy-duty series

Thread size d ₁ 5H	Thread size D 4h	Order reference	L ± 0,3	L ₁ * L ₁	d ₂ 	d ₃ 6H	d ₄	T min.	A [mm ²]
M5	M10x1,25	KNHML 5x0,8	10,0	8,7	8,8	M10x1,25	10,25	13,0	152,7
M6	M12x1,25	KNHML 6x1	12,0	9,5	10,8	M12x1,25	12,25	15,5	242,5

* L₁ = minimum screw-in depth

Threaded inserts

4 key locks



Types KNM, KNHM

Material

Stainless steel 1.4305 / AISI 303

Extraction force [N]

Shear engagement „A [mm²]“ x ultimate shear strength of parent material „R_m [N/mm²]“

KEENSERTS® with UNC or UNF threads, MS and NAS specification are available upon request.

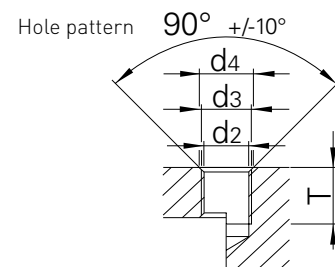
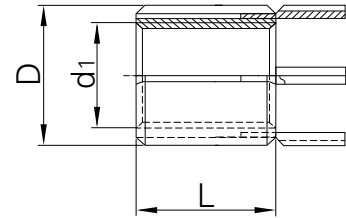

Typ KNM, standard series

Thread size d ₁ 5H	Thread size D 4h	Order reference	L ± 0,3	d ₂	d ₃ 6H	d ₄	T min.	A [mm ²]
M8	M12 x1,25	KNM 8x1,25	12,0	10,80	M12x1,25	12,25	15,5	266,7
M10	M14x1,50	KNM 10x1,5	14,0	12,80	M14x1,50	14,25	18,0	341,6
M12	M16x1,50	KNM 12x1,75	16,0	14,75	M16x1,50	16,25	20,0	470,2

Typ KNHM, heavy duty series

Thread size d ₁ 5H	Thread size D 4h	Order reference	L ± 0,3	d ₂	d ₃ 6H	d ₄	T min.	A [mm ²]
M8	M14x1,50	KNHM 8x1,25	14,0	12,80	M14x1,5	14,25	18,0	341,6
M10	M16x1,50	KNHM 10x1,5	16,0	14,75	M16x1,5	16,25	20,0	470,2
M12	M18x1,50	KNHM 12x1,75	18,0	16,75	M18x1,5	18,25	23,0	608,5
M16	M22x1,50	KNHM 16x2	22,0	20,50	M22x1,5	22,25	27,0	896,8

Threaded inserts

4 key locks, self-locking



Types KNML, KNHML

The self-locking feature is designed similarly to MIL-N-25027 and supplied with MIL-L8937 lubrication.

Material

Stainless steel 1.4305 / AISI 303 with Molykote® surface treatment

Extraction force [N]

Shear engagement „A [mm²]“ x ultimate shear strength of parent material „R_m [N/mm²]“

KEENSERTS® with UNC or UNF threads, MS and NAS specification are available upon request.

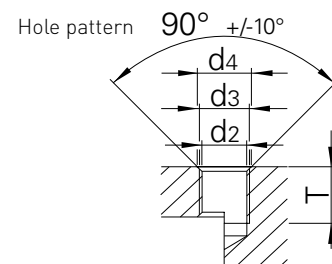
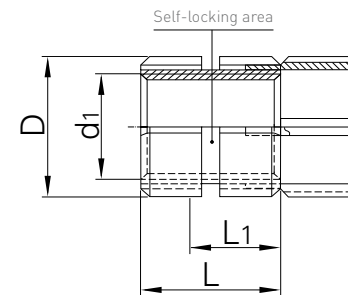

Typ KNML, standard series

Thread size d ₁ 5H	Thread size D 4h	Order reference	L ± 0,3	L ₁ * 9,5	d ₂ 	d ₃ 6H	d ₄	T min.	A [mm ²]
M8	M12x1,25	KNML 8x1,25	12,0	9,5	10,80	M12x1,25	12,25	15,5	242,5
M10	M14x1,50	KNML 10x1,5	14,0	10,0	12,80	M14x1,50	14,25	18,0	316,4
M12	M16x1,50	KNML 12x1,75	16,0	11,2	14,75	M16x1,50	16,25	20,0	441,4

Typ KNHM, heavy duty series

Thread size d ₁ 5H	Thread size D 4h	Order reference	L ± 0,3	L ₁ * 10,0	d ₂ 	d ₃ 6H	d ₄	T min.	A [mm ²]
M8	M14x1,50	KNHML 8x1,25	14,0	10,0	12,80	M14x1,5	14,25	18,0	316,4
M10	M16x1,50	KNHML 10x1,5	16,0	10,0	14,75	M16x1,5	16,25	20,0	441,4
M12	M18x1,50	KNHML 12x1,75	18,0	10,7	16,75	M18x1,5	18,25	23,0	561,8
M16	M22x1,50	KNHML 16x2	22,0	12,4	20,50	M22x1,5	22,25	27,0	855,2

* L₁ = minimum srew-in depth

Tool | Installation

Tool for threaded inserts with 2 or 4 key locks

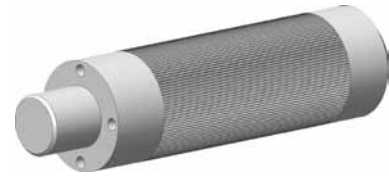

Internal thread KEENSEERTS®	Types KNCM small series and KNM, KNML	Types KNHN, KNHML heavy duty series
	Order reference	Order reference
M3	KRTM 3 - 01	
M4	KRTM 4 - 01	
M5	KRTM 5 - 01	KRTM 5 - 02
M6	KRTM 6 - 01	KRTM 6 - 02
M8	KRTM 8 - 01	KRTM 8 - 02
M10	KRTM 10 - 01	KRTM 10 - 02
M12	KRTM 12 - 01	KRTM 12 - 02
M16		KRTM 16 - 02

Installation

1. Manually screw the KEENSEERTS® threaded insert on the mandrel using 2 - 3 turns.
2. Attach the installation tool, including the spigot, and turn it until the key locks snap in the bore hole. Continue the screwing process until the KEENSEERTS® threaded insert is fully screwed in.
3. Hitting the tool with a hammer, drive the snapped in key locks in until they touch the material.
4. Slightly lift the tool and it turn clockwise by about 45°.
5. Hitting the tool with a hammer, drive the keylocks in completely until the tool is once again flush with the surface.
6. Installation complete.



KVT-Fastening – Fastening technology



Blind rivet nuts



Blind rivet technology



Thread inserts



Self-clinching fasteners



Stud welding systems¹⁾



Lock nuts



Bonding fasteners



Access solutions



Quick fastening elements and clips



Quick release pins and spring plungers



Adhesives and sealants¹⁾



Construction fasteners²⁾



Special processes²⁾



Plugs



Pressure intensifiers³⁾



Installation technology



Quick connectors⁴⁾

Fastening, sealing and flow control solutions for complex applications

The extensive KVT-Fastening portfolio offers optimal solutions for your most challenging applications. The products included in this catalog represent only a selection from our entire product portfolio. Upon request, we will be pleased to provide additional information or an individual consultation to you.

Intelligent logistic systems

Bossard SmartBin and SmartLabel are intelligent logistics systems which monitor stock with total reliability and ensure stock replenishment automatically. An online system transmits the data to our server, and this – if necessary – triggers an order. These systems ensure quick and easy availability of C-parts while production is running.



Logistic systems

Competent analysis for efficient solutions

KVT-Fastening's highly qualified experts analyze the given task at hand. Based on this sound understanding of the project, they then develop ideal solutions that are economical, efficient, and safe.



Solutioneering

For more information about our range of products and order at our E-shop, please visit www.kvt-fastening.com

¹⁾ Not available in Germany. ²⁾ Only available in Switzerland. ³⁾ Not available in Switzerland. ⁴⁾ Not available in Austria.

KVT-Fastening AG

Dietikon/Zürich | Switzerland
Tel: +41 44 743 33 33
info-CH@kvt-fastening.com
www.kvt-fastening.ch

KVT-Fastening GmbH

Illerrieden | Germany
Tel: +49 7306 782-0
info-DE@kvt-fastening.com
www.kvt-fastening.de

KVT-Fastening GmbH

Asten/Linz | Austria
Tel: +43 7224 67 09 0
info-AT@kvt-fastening.com
www.kvt-fastening.at

KVT-Fastening Sp. z o.o.

Radom | Poland
Tel: +48 58 762 17 80
info-PL@kvt-fastening.com
www.kvt-fastening.pl

KVT-Fastening S.R.L.

București | Romania
Tel: +40 37 1381155
info-RO@kvt-fastening.com
www.kvt-fastening.ro

KVT-Fastening spol. s.r.o.

Bratislava | Slovakia
Tel: +421 9 11102510
info-SK@kvt-fastening.com
www.kvt-fastening.sk

KVT-Tehnika pritrjevanja d.o.o.

Ljubljana | Slovenia
Tel: +386 1 2808019
info-SI@kvt-fastening.com
www.kvt-fastening.si

KVT-Fastening s.r.o.

Brno | Czech Republic
Tel: +420 547 125200201
info-CZ@kvt-fastening.com
www.kvt-fastening.cz

KVT-Fastening Kft.

Budapest | Hungary
Tel: +36 1 769 0925
info-HU@kvt-fastening.com
www.kvt-fastening.hu



www.kvt-fastening.com

